



High Precision Heat Alarm

CODE: QFS-ELCON5-IH

Interlinkable

Elite Series



Features

- Hardwired as standard, with 9V battery backup
- Interlink devices via wired connection with other alarms
- NTC thermistor sensor to detect temperature
- Compliant with BS5446-2:2003
- Alarm sounder (85dB)



GONEGT+

Specification	QFS-ELCON5-IH
Power	220-240V; 50Hz (with 9V battery backup)
Alarm Volume	>85dB (A) at 3m
Alarm Sensitivity	54°C to 65°C
Silence Time (Mute)	8 minutes
Compliance Standard	BS 5446-2:2003
Local Heat Alarm Sound Pattern	ISO8201; (Beep 0.5s > Pause 0.5s > Beep 0.5s > Pause 0.5s > Beep 0.5s > Pause 1.5s; Accompanied by red LED flash) [repeat]
Wired Alarm Sound Pattern	Two beeps > Pause 1.2s; Accompanied by red LED Flash [repeat]
Maximum Interlinked Devices	x40 devices
Mounting	Mount onto base









High Precision Heat Alarm

CODE: QFS-ELCON5-IH

Interlinkable

Elite Series

Functions

Normal	Red LED flashes once (40 seconds); Green LED is always on	 40
Fault	Buzzer sound every 40 seconds	 40
Low Power	Buzzer sound every 40 seconds (indicating a fault)	 40
Alarm	Pulsating buzzer; Accompanied by red LED flashing every 1 second	 1
Mute	Silent buzzer; Red LED flash every 10 seconds for 8 minutes	 10 8min
Test	Imitates LED & buzzer pattern as per 'Alarm Mode'	 1

WARNING

When the power is low, or service life reaches 10 years, the alarm should be replaced. In any doubt, an alarm trigger should be assumed to be due to a fire and appropriate measures must be taken immediately.



High Precision Heat Alarm

CODE: QFS-ELCON5-IH

Interlinkable

Elite Series

Hardwired Install & Device Linking

1) Prepare Wires	Strip the live, neutral and interconnect (if connecting other devices) wires as per diagram 1 shown below
2) Terminals	As per diagram 2, connect the wires to corresponding terminals and ensure terminal screws are properly tightened. Close the terminal cover to avoid contact with live terminals
3) Connect Devices	Devices must be linked together using the interconnect wire (no more than 150m between each alarm)
4) Clip to Base	If base is screwed to the ceiling and a battery is installed, the alarms should clip on (this will not work without battery)
5) Testing	A test should be initiated before use (see previous page)

Wire Stripping

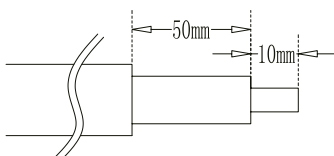

Connect Wires

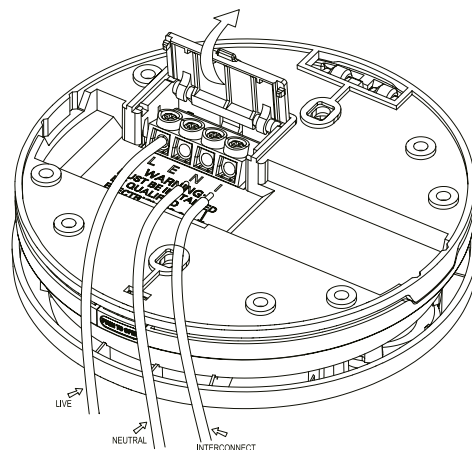

Close Terminal

